

Venus V Series Curtain Tracking



V21 Series

Heavy Duty Applications

Maximum loading
Up to 20 kg per track metre

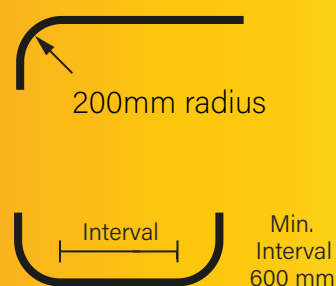

European
Design

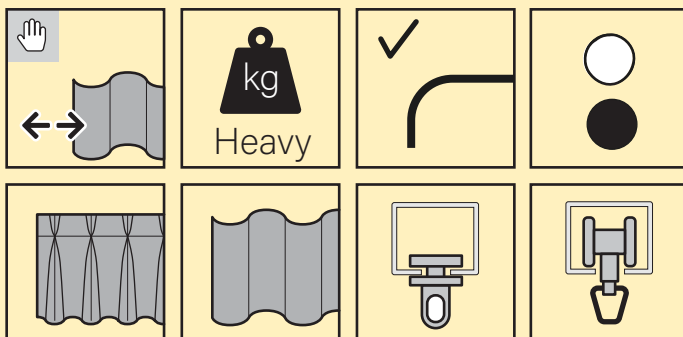
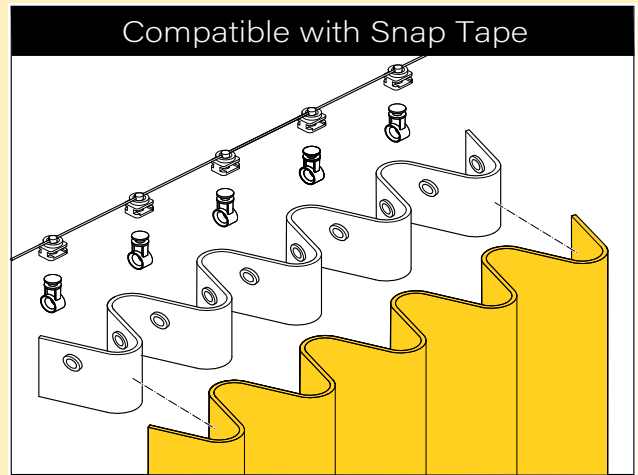
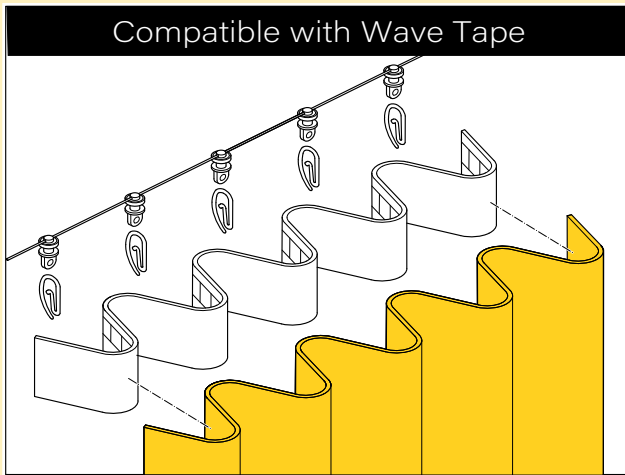
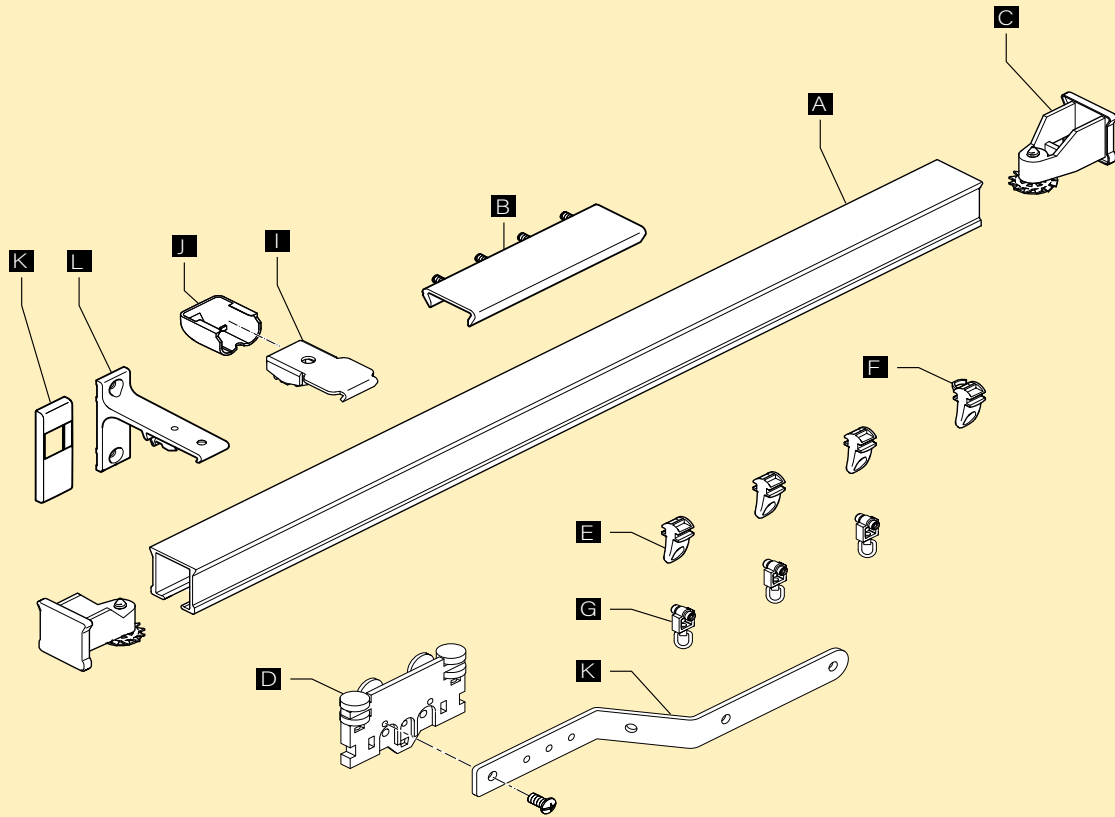

- Hand Draw
- Heavy Capacity
- Bendable
- Standard Colours:
White and Black
- Pleats or Ripple
- Glider or Roller

A 80-022-xxx

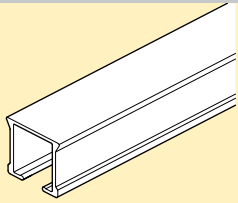

V21 Track (5.8m length)
White, Black

B 80-701-000

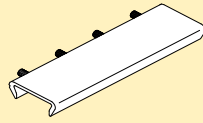

V21 Joiner
Aluminium

C 80-814-000

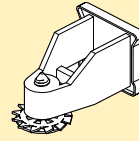

V21 End Cap
White, Black

E 80-800-000

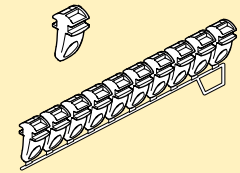

V21 Standard Glider
White, Black

H 80-829-000

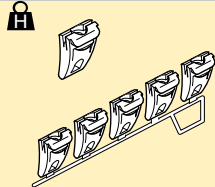

Heavy Duty Glider
White, Black

F 80-802-000

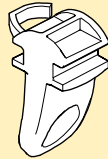

Brake Glider
White, Black

G 80-804-000

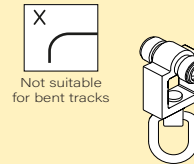

V14 Roller Glider
White, Black

80-826-000



Economy Glider
White, Black

I 80-102-000

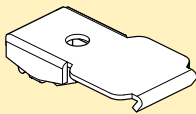

Top Fix Easi Bracket
White, Black

J 80-112-000

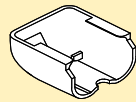

Top Fix Easi Cover
White, Black

80-118-000

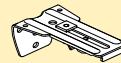

Light Duty Single Wall Bracket
White, Black

80-120-000

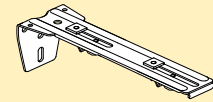

Light Duty Double Wall Bracket
White, Black

L 80-130-000

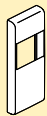

Heavy Duty Wall Bracket Cover
White, Black

80-124-000

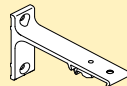

Heavy Duty Single Wall Bracket
White, Black

80-126-000

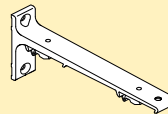

HD 150mm Double Wall Bracket
White, Black

80-128-000

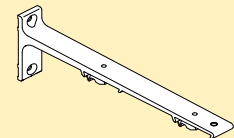

HD 200mm Double Wall Bracket
White, Black

80-650-000

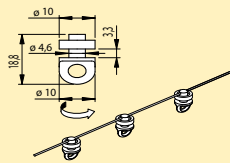

Standard S-Wave 60mm Runner
White, Black

80-648-000

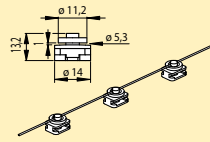

Snapcarrier 54mm 2x Fullness
White

80-646-000

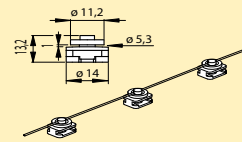

Snapcarrier 60mm 1.8x Fullness
White, Black

80-650-000

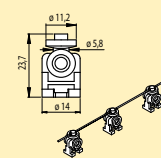

Wheeled Snapcarrier
54mm 2x Fullness
White, Black

80-660-000

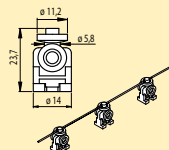

Wheeled Snapcarrier
54mm 1.8x Fullness
White, Black

Capacity

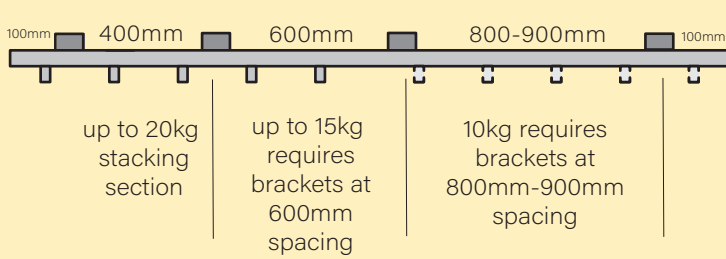

For 1 glider



1.5 kg

Calculate maximum curtain load in track stacking sections. Do not exceed guidelines.

- Consider additional brackets at stacking points and before and after joins/bends.
- The capacity and fixing distances are provided as a guide.
- They may vary depending on fixing strength, additional fixing brackets in stacking areas, etc.

Glider Options/Dimensions

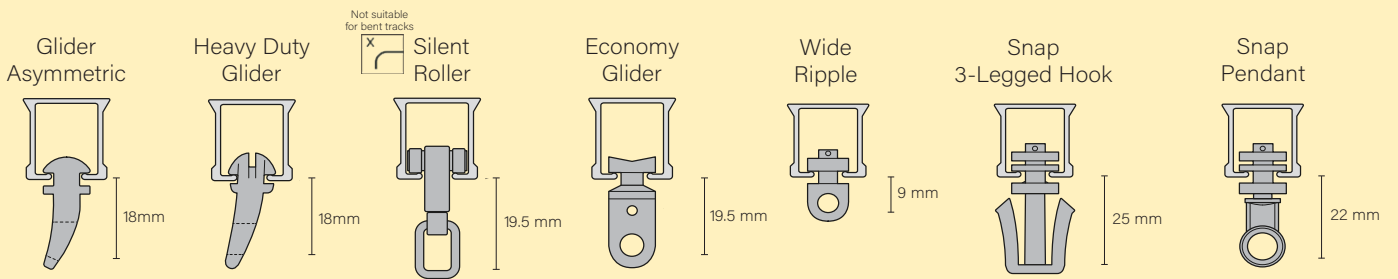

Bracket Options/Dimensions

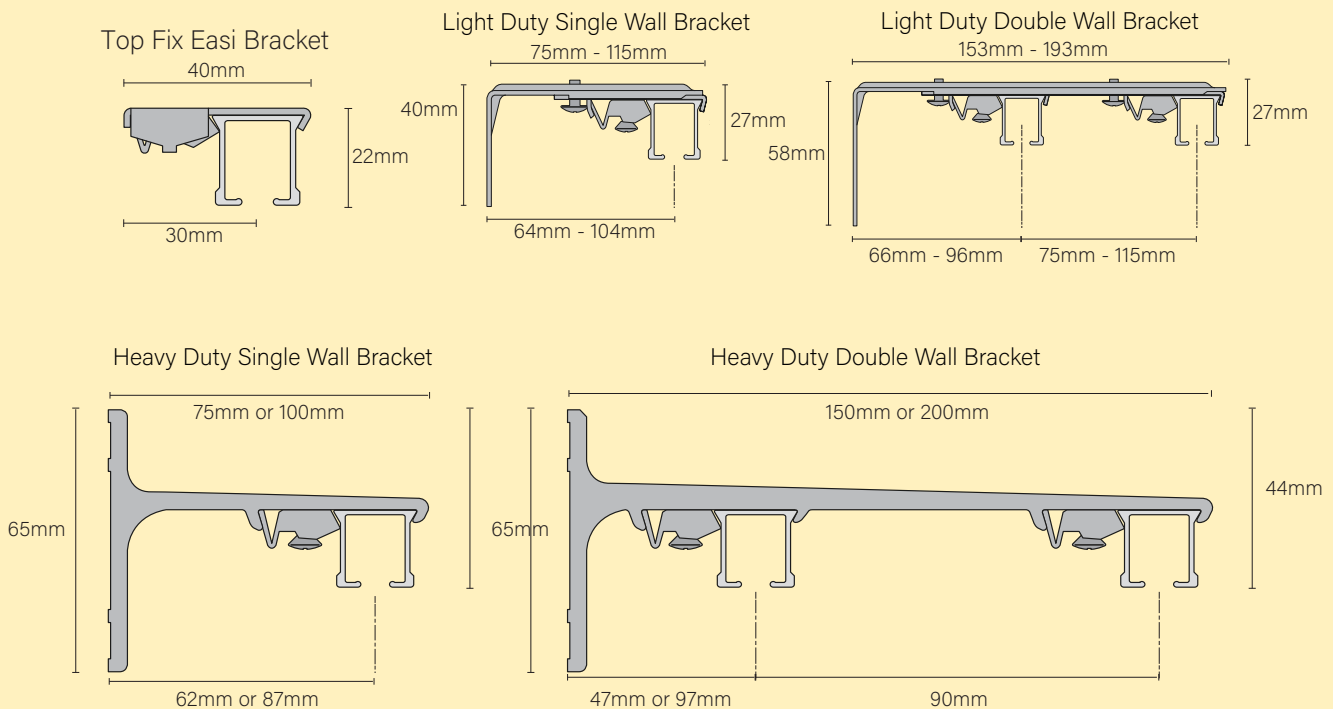

3/14 Tennyson Road
Gladesville NSW 2111

02 9807 5588
sales@venus.com.au

